

Measuring Guidelines

Table of Contents	Page
1. Panel Anatomy	1
2. Basic Measuring	2
3. Mounting Options	2
4. General Frame Categories	4
• Frame Decision Tree	
• Number of Sides	
5. Measuring for	7
• Different Frames	
• Direct Mount	
• Standard Deduction	
• Café Shutter	
• Corner Window	
• Bay Window	
• T Post	
• Other Window Situation	

Panel Anatomy

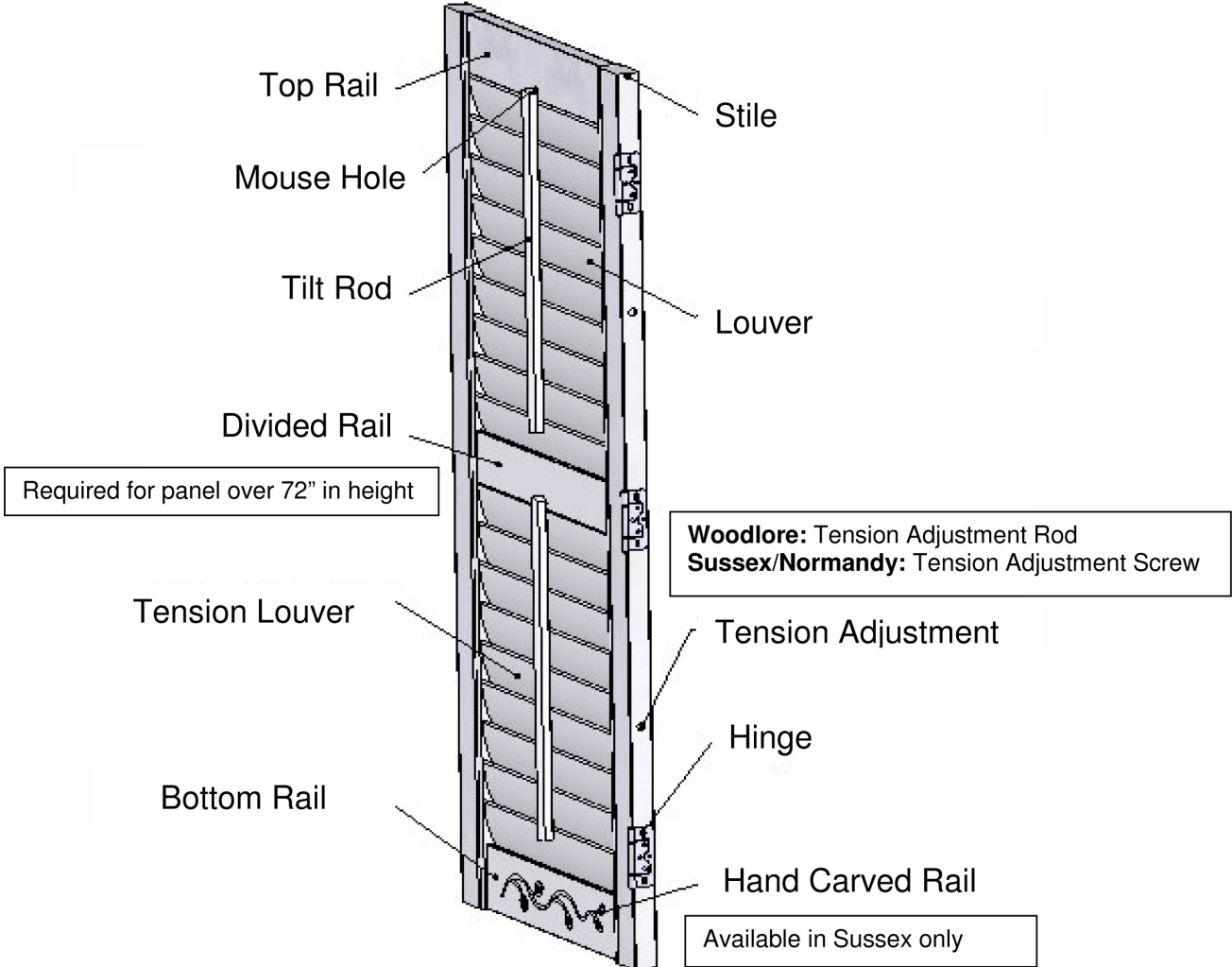

Basic Measuring

To get a precise and accurate measurement is the first step to a perfect shutter.

- ◇ Always use a metal measuring tape.
- ◇ Always measure to the closest $\frac{1}{16}$ ”.

To measure your window

Width: Take 3 measurements at the top, middle and bottom of the window opening.

Height: Take 3 measurements at the left, center and right of the window opening.

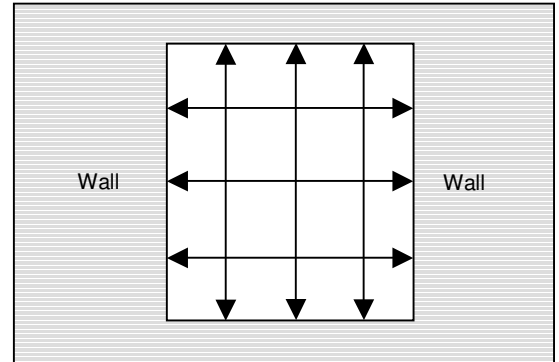

Mounting Options

Inside Mount (IM)

- Shutters will fit inside a window opening.
 - There must be enough unobstructed depth on the mounting surface inside the window opening.
- For **IM**, please provide the **SMALLEST** height and width measurement among the three.

Outside Mount (OM)

- Shutters will fit outside a window opening.
 - There must be sufficient flat mounting surface around the window opening.
- For **OM**, please provide the **LARGEST** height and width measurement among the three.

Tip: When there is enough flat mounting surface, Outside Mount is generally a preferred method as it is more forgiving and less challenging compare to Inside Mount.

Basic Measuring

Determine Window Squareness

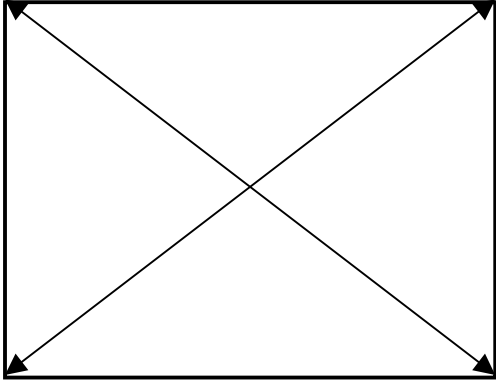

- Measure diagonally with a metal measuring tape
- Should the difference between the two diagonal measurements be greater than $\frac{1}{4}$ ", OM is highly recommended.

Measurement Type

- **Max Frame to Frame (MFF)**
Finished size of the shutters, measure from the outside edge of the left to right and the top to bottom frame.
- **Window Size (WS)**
Exact size of the window opening

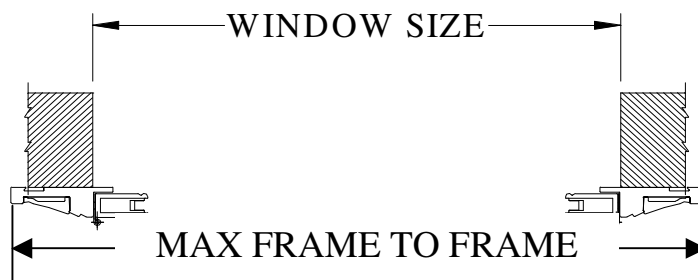

General Frame Categories

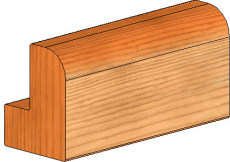

L Frame

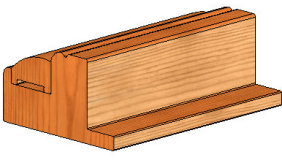

Deco Frame

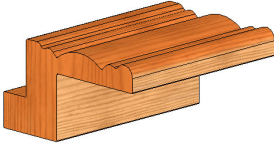

Z Frame

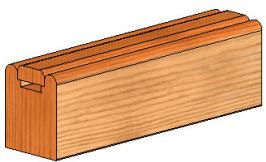

Hang Strip

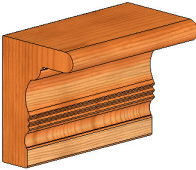

Sill Frame

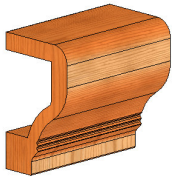

Designer Sill Cap

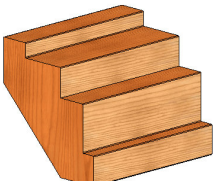

Corner Post

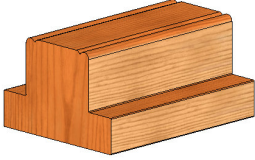

T Post

Frame Decision Tree

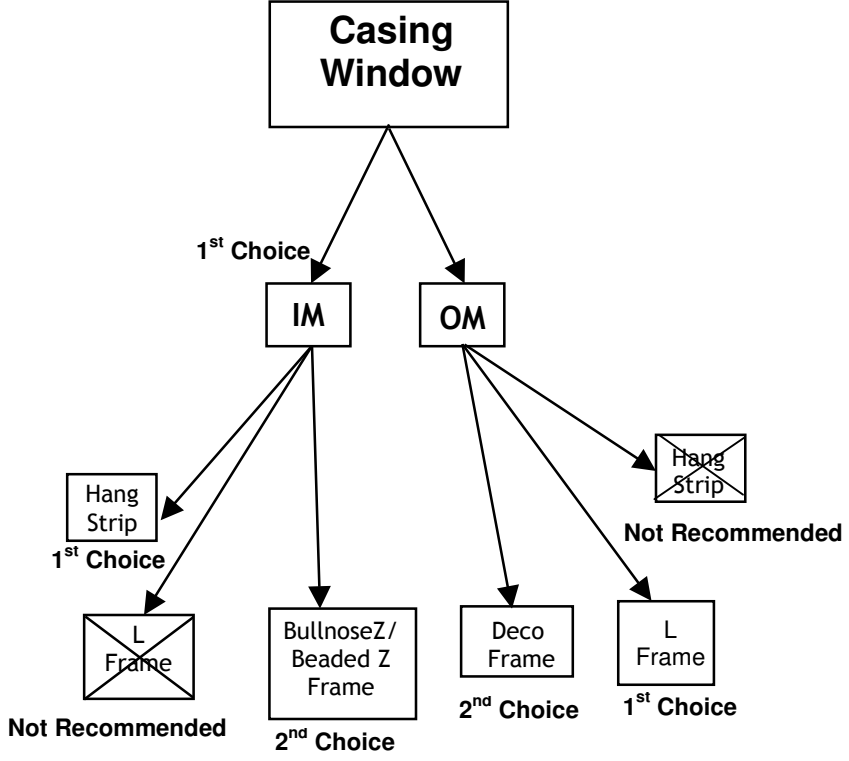
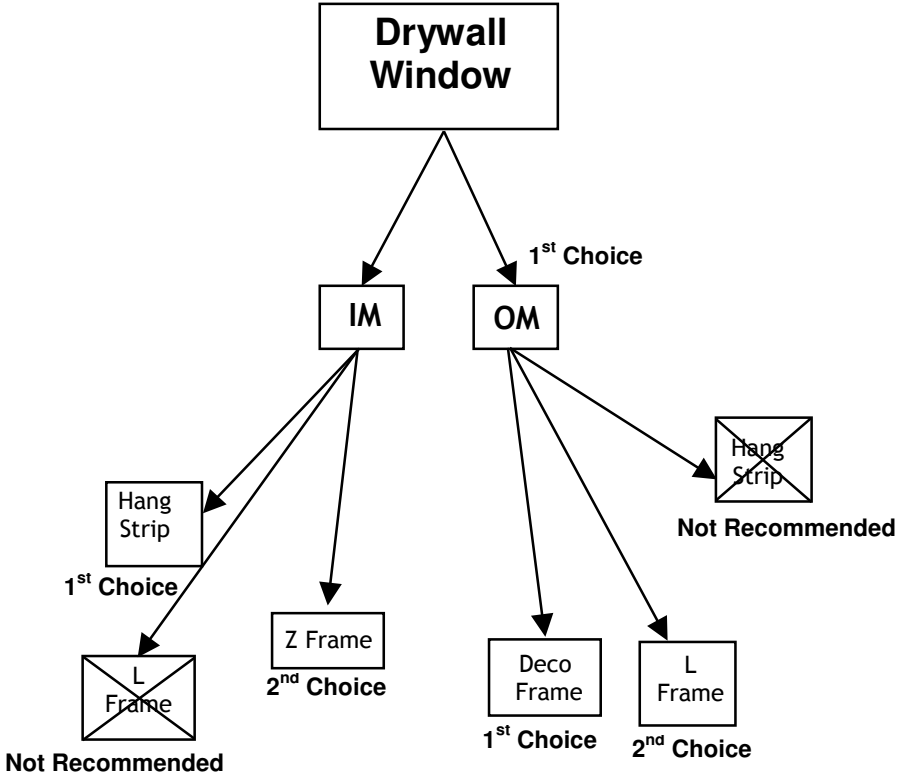

Number of Sides

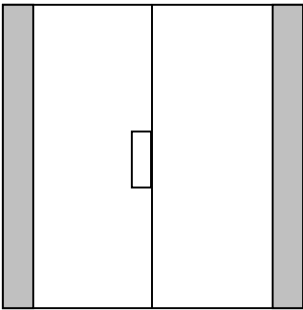

2-sided

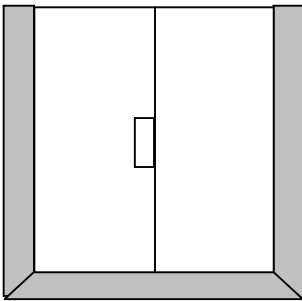

3-sided

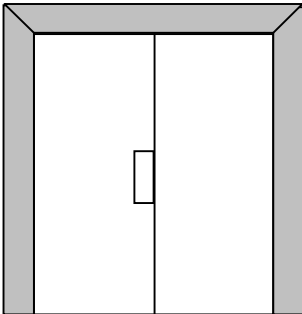

3-sided

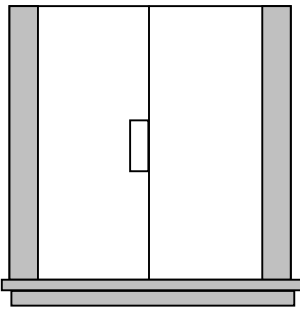

2-sided + Deco Sill Frame/
Designer Sill Cap

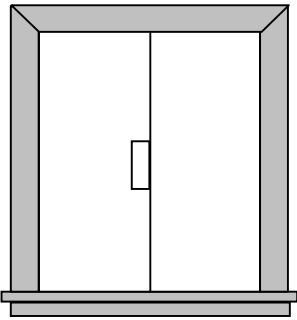

3-sided + Deco Sill Frame/
Designer Sill Cap

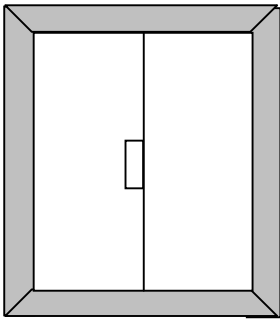

4-sided

Measuring For Different Frames

L Frame

- OM or IM

OM

- The edge of L frame usually aligns with the window edge.
Under situation where there is moldings around the window, L frame can be mounted on the outside edge of the molding or on top of the molding.

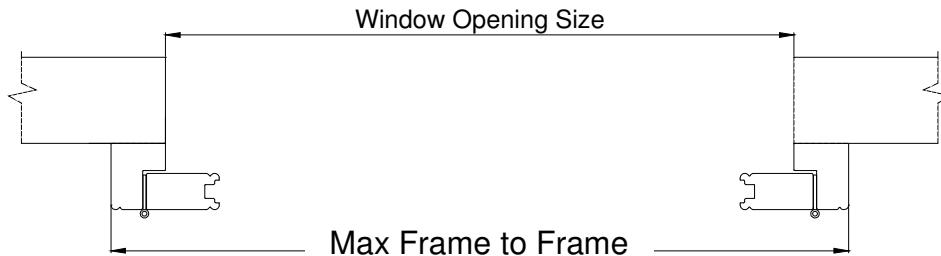

IM

- Max Frame to Frame measurement is **required** for L frame inside mount.
- $\frac{1}{16}$ " is the suggested deduction on each side.



Feature:

- *L Frame OM leaves more room on the inside of the window opening as it protrudes more into the room compares to other frames.*

Note:

For 2-sided L Frame (IM & OM)
other than café shutter,
standard deduction for

Frame Height = $\frac{1}{16}$ "
Panel Height = $\frac{1}{4}$ "

unless specify otherwise.

Measuring For Different Frames

Hang Strip

- OM or IM

IM

- Hang strip is placed behind the panel.
- Shutters come with two pre-drilled hang strips only. Two light blocks will be provided for the top and bottom of the window opening.

• Window size measurement

- ◇ Standard deduction for gap between panel and window casing = $\frac{1}{8}$ " for width, $\frac{1}{8}$ " to $\frac{3}{16}$ " for height.

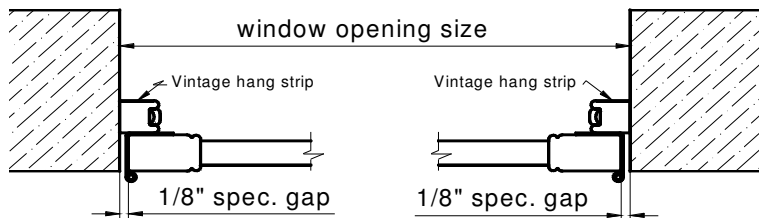

• Max Frame to Frame measurement

- ◇ Max Frame to Frame width = panel width (not include hinges).
- ◇ Max Frame to Frame height = panel height
- ◇ The total length for hang strip will be $\frac{1}{10}$ " more than panel height.

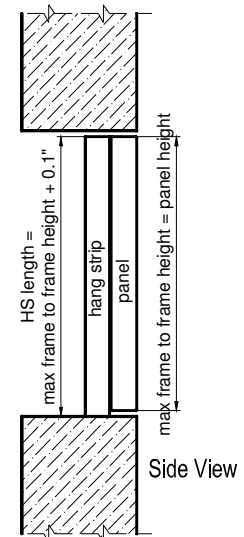
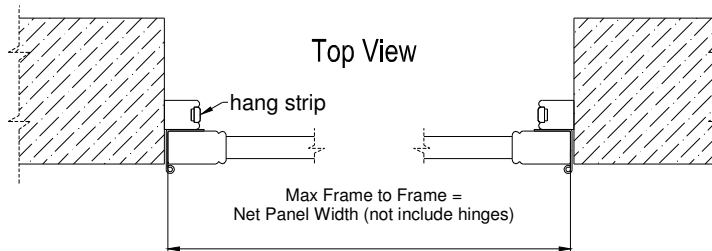

Measuring For Different Frames

Hang Strip

OM

- Hang strip is placed on the side of the panel
- Panel is $\frac{1}{2}$ " wider than the window opening on both left and right side

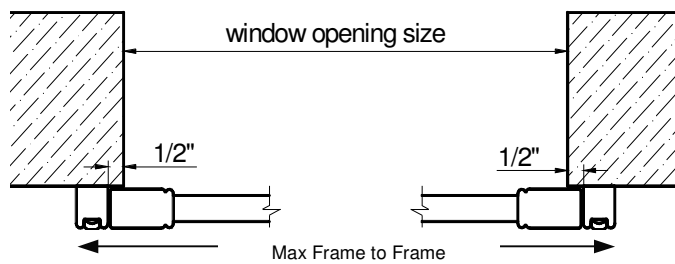

**Hang strip OM; beside the panels
(shown in Vintage Hang Strip)**

Note:

For 2-sided Hang Strip (OM)
other than café shutter,
standard deduction for

Frame Height = $\frac{1}{16}$ "
Panel Height = $\frac{1}{4}$ "

unless specify otherwise.

Feature:

- *An innovative frame design for easier installation. Hang strip comes with pre-drilled holes and can be installed with screws that will be hidden under the inserts.*

Measuring For Different Frames

Deco Frame

- OM only
- Must have enough flat surface around the window opening for frame installation.

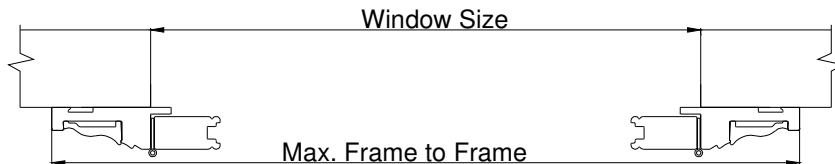

Note:
For 2-sided Deco Frame (OM)
other than café shutter,
standard deduction for

Frame Height = $\frac{1}{16}$ "
Panel Height = $\frac{1}{4}$ "

unless specify otherwise.

Feature:

- *Deco frame can help to hide an imperfect window.*
- *The elegant frame profile adds a decorative touch to an ordinary window.*
- *An innovative frame design for easier and touch-up free installation. Deco frame comes with pre-drilled holes and can be installed with screws that will be hidden under the inserts.*

Z Frame

- IM only
- Standard deduction = $\frac{1}{16}$ " (all sides for window size)

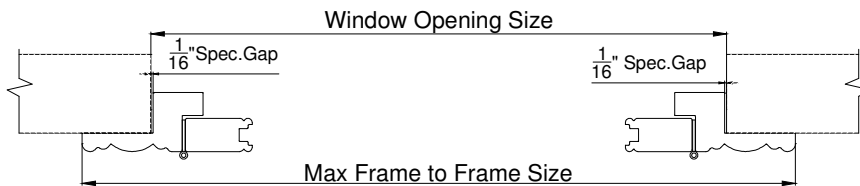

Note:
For 2-sided Z Frame (IM) other
than café shutter,
standard deduction for

Frame Height = $\frac{1}{16}$ "
Panel Height = $\frac{1}{4}$ "

unless specify otherwise.

Feature:

- *Z frame is less protruding into the room.*
- *It can help to hide an imperfect window.*
- *The elegant frame profile adds a decorative touch to an ordinary window.*

Measuring For Different Frames

Deco Sill Frame/Designer Sill Cap

- Window Size Measurement:

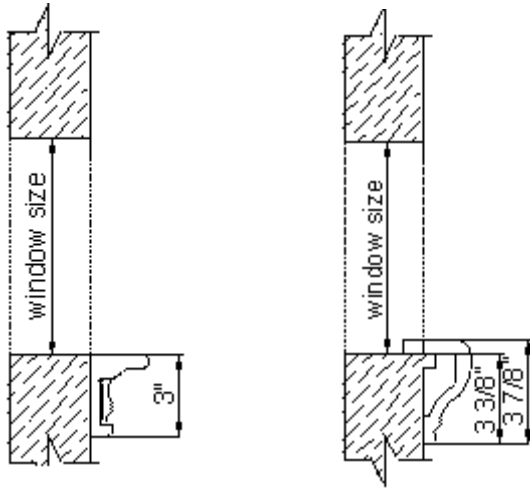

* If extension is requested behind regular frames, then extension will also be added behind sill frame.

- Max Frame to Frame Measurement:

- ◇ Measure height from the top of top frame to bottom of Deco Sill or Designer Sill Cap.

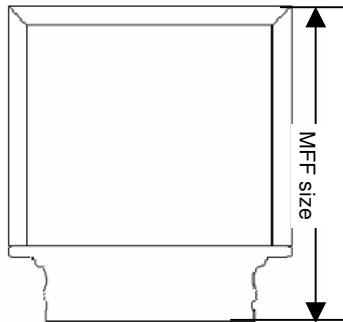

- ◇ To eliminate the gap between the side frame and the bullnose edge of the sill frame (see drawings below), sill frame will be extended $\frac{1}{2}$ " on both sides by default or 1" (optional).

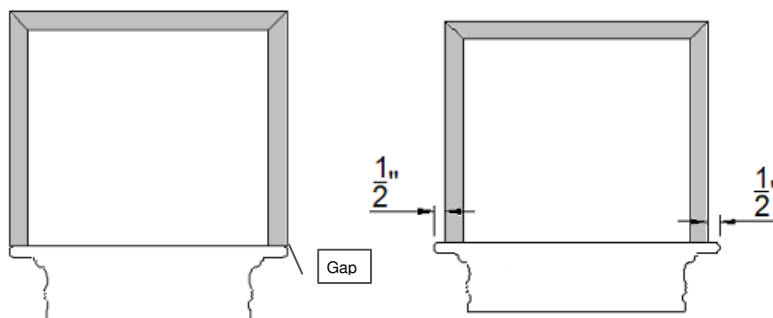

Measuring For Different Frames

Direct Mount

- Shutters are directly hinged to window jambs.
- Hardware, including self mortised hinges and magnets, are mounted onto the panels
- Comes with 4 light blocks, with magnet catches installed on top/bottom light blocks.
- For hinge, part goes on the panel is pre-installed while part goes on the window jamb and hinge pin are included in the hardware box.
- Astragal stile is highly recommended in this mounting option to minimize light gap between panels.
- For shutters used as a door or without bottom support, please refer to the General Product Specification section for details.

Window Size measurement

- Measure both width and height from the inside of window.

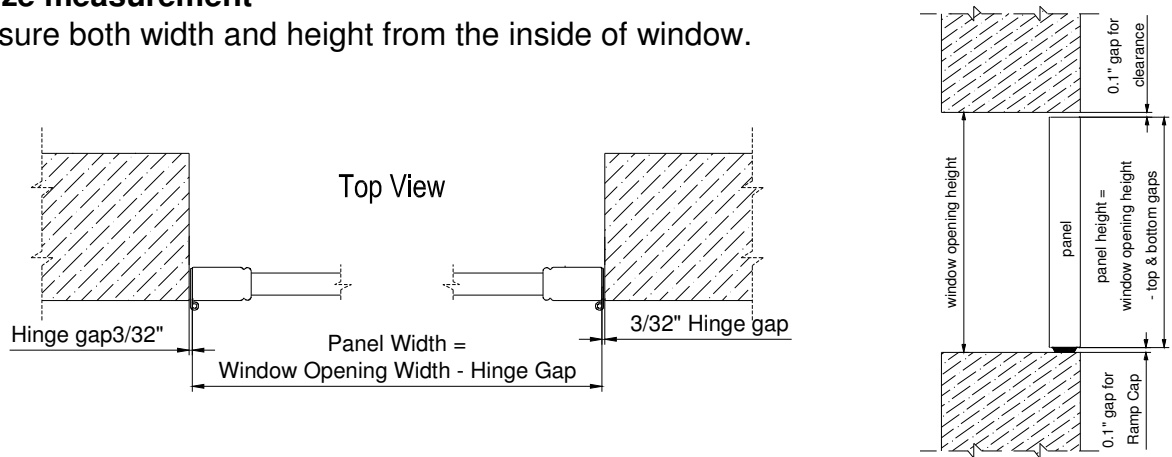

Max Frame to Frame measurement

- Equal to panel size.
- Please note that the Max Frame to Frame width should not include hinge between panel and window jamb.

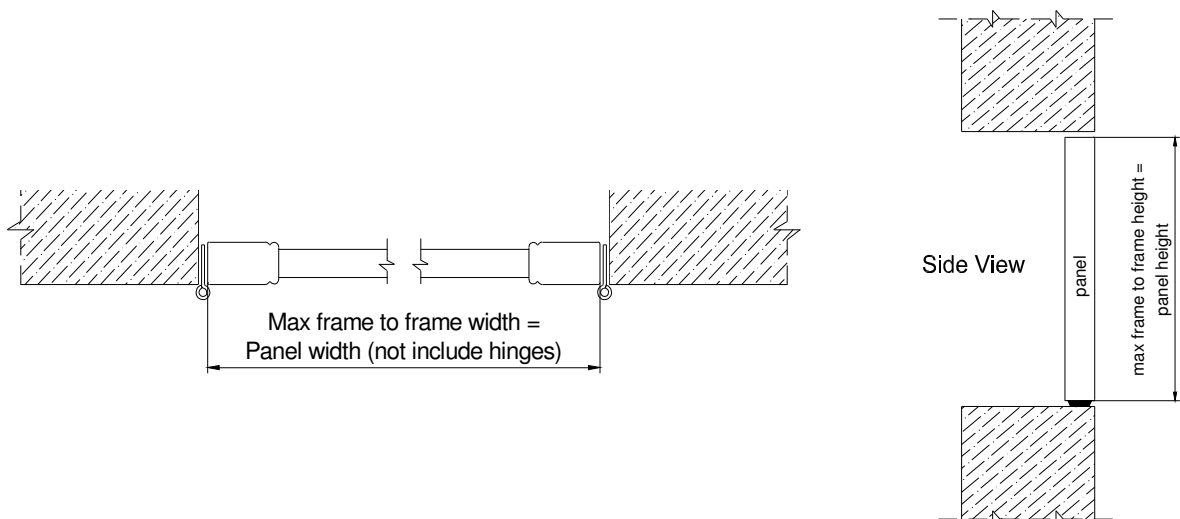

Measuring For Café Shutters

Café Shutters

- The top of the panel requires special finish. Please indicate “café shutter” when placing orders.
- Shutter does not come with recessed magnet on top.

WS = Window Size

MFF = Max Frame to Frame

Window size measurement

Panel Height: From bottom of window to top of panels

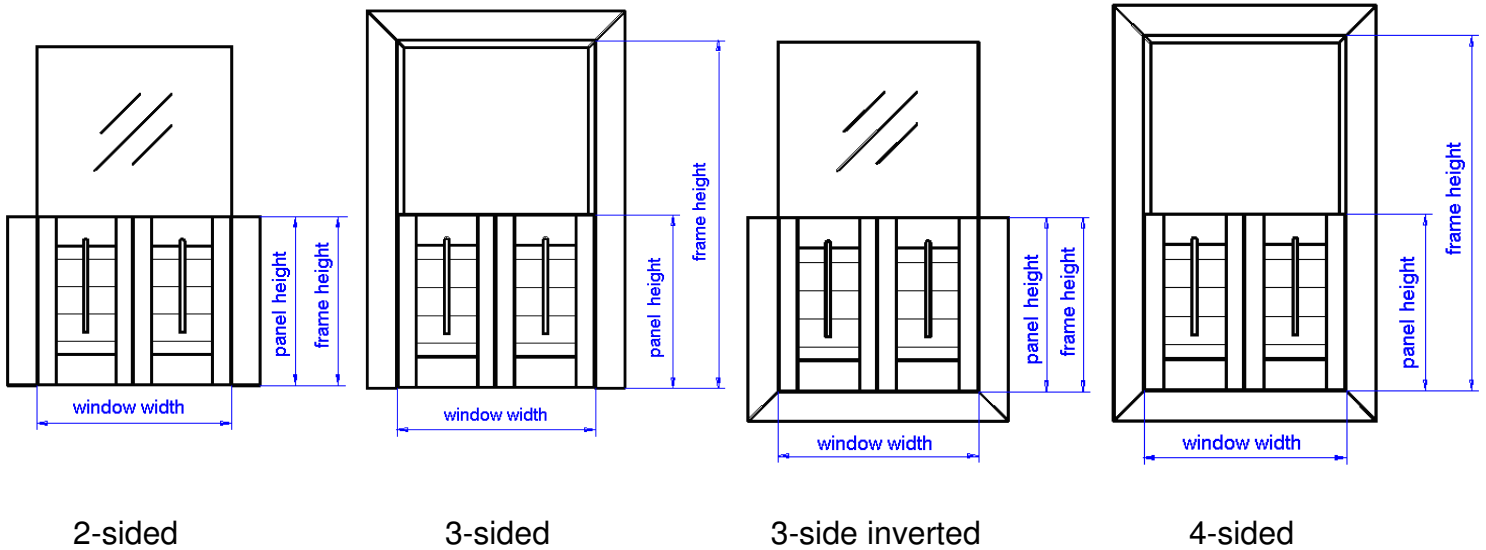

Max frame to frame size measurement

Panel Height: From bottom of frame to top of panels

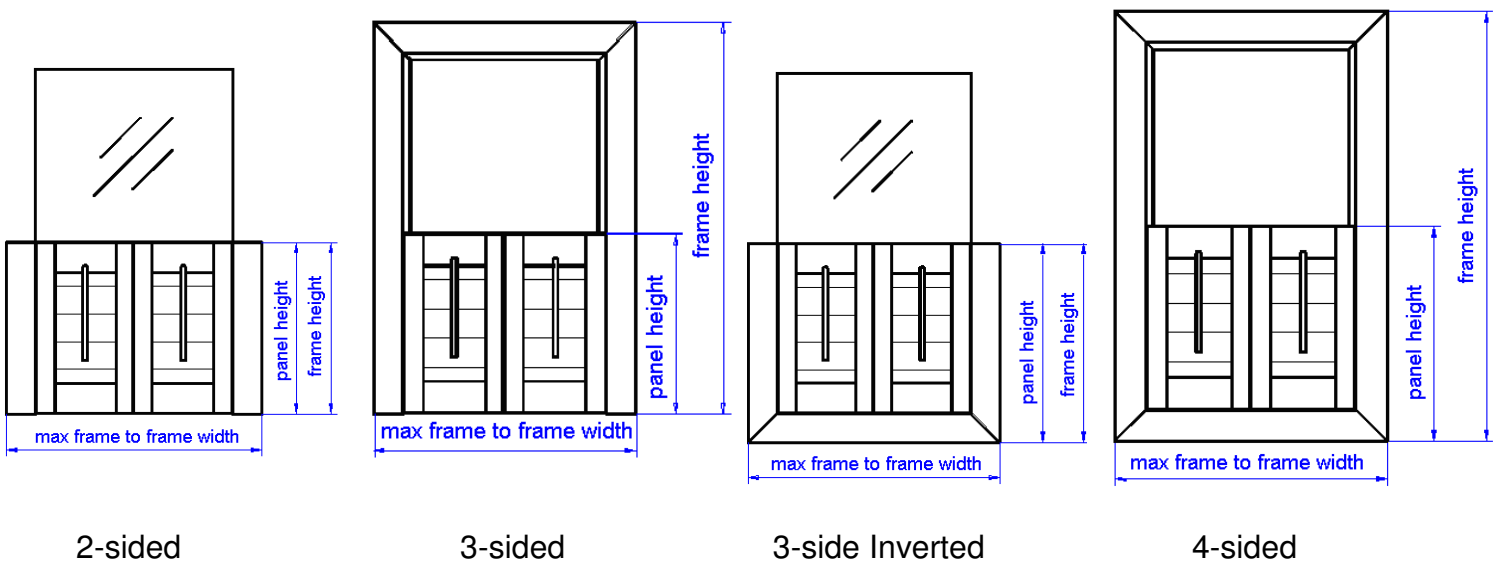

Measuring For Corner Window

Corner Window

- Shutter is made as a single unit with corner post to cover both window
- Standard angle = 90° (For other angles, please refer to Bay Window section)
- Width will be different at different depths in window. To get an accurate measurement, please decide **where frames will be mounted on** and then measure width at correct place as shown in the corner window drawings.

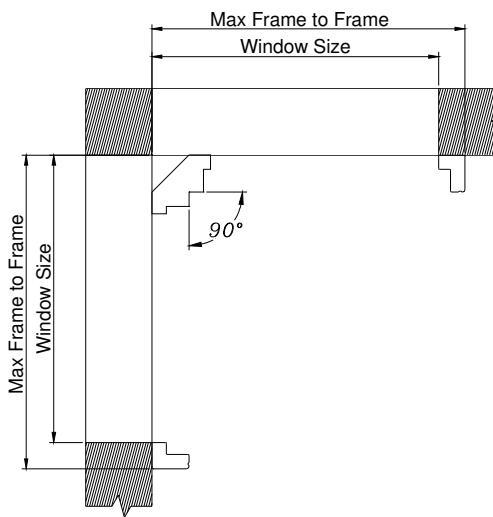

L Frame Outside Mount
(Corner window with a break)

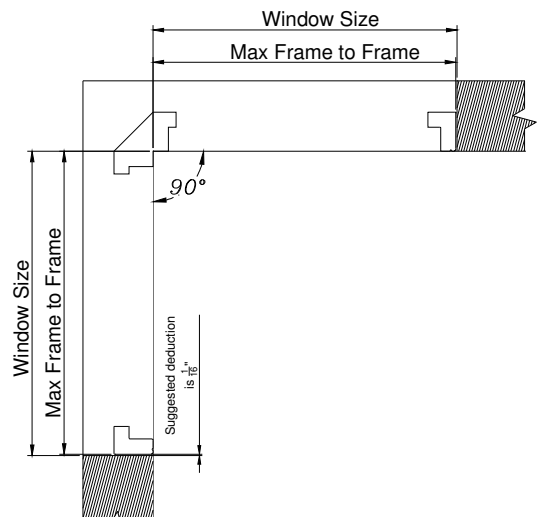

L Frame Inside Mount
(Continuous Corner Window)

Measuring For Corner Window

Corner Window (con't)

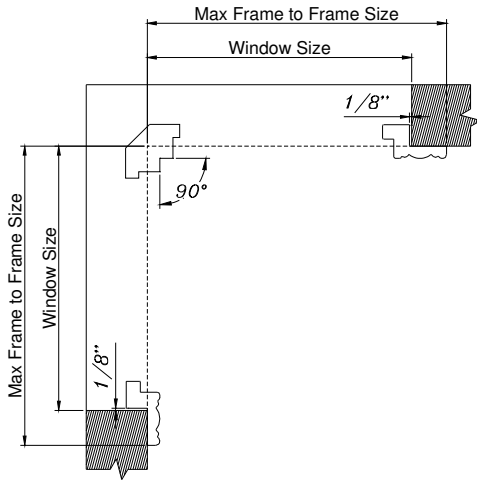

**Z Frame Inside Mount
(Continuous Corner Window)**

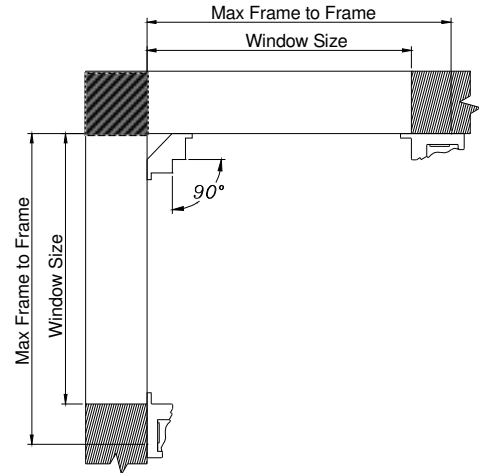

**Deco Frame Outside Mount
(Corner Window with a Break)**

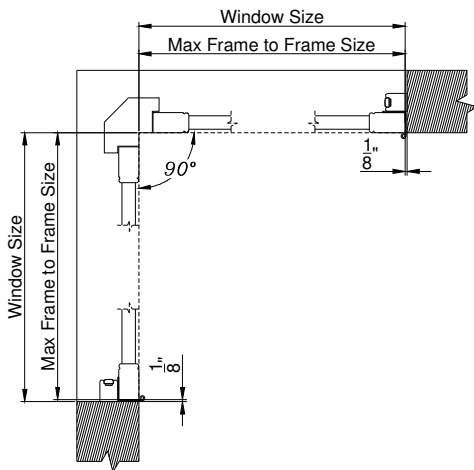

**Hang Strip Inside Mount
(Continuous Corner Window)**

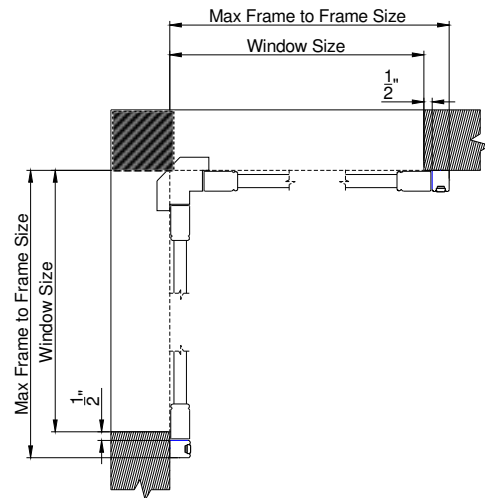

**Hang Strip Outside Mount
(Corner Window with a Break)**

Measuring For Bay Window

Bay Window

- Shutter is made as a single unit with bay post to cover both window
- Standard angle = 135° (Custom angle is available)
- Width will be different at different depths in window. To get an accurate measurement, please decide where frames will be mounted on and then measure width at correct place as shown following diagrams.

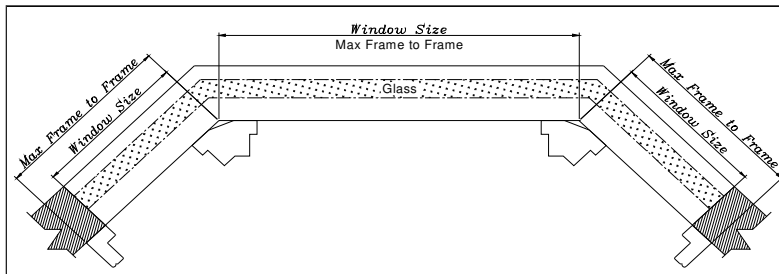

L Frame Outside Mount

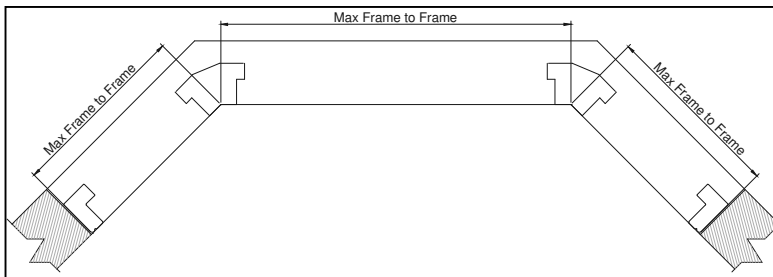

L Frame Inside Mount

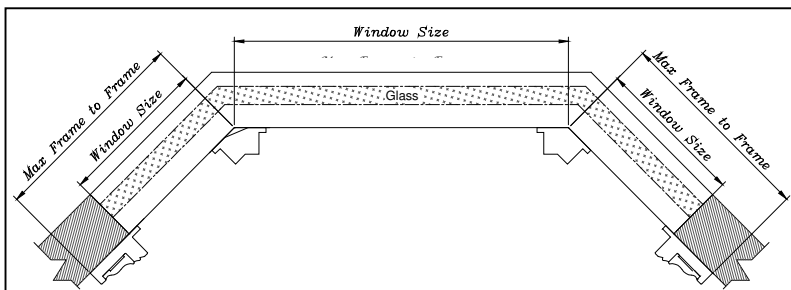

Deco Frame Outside Mount

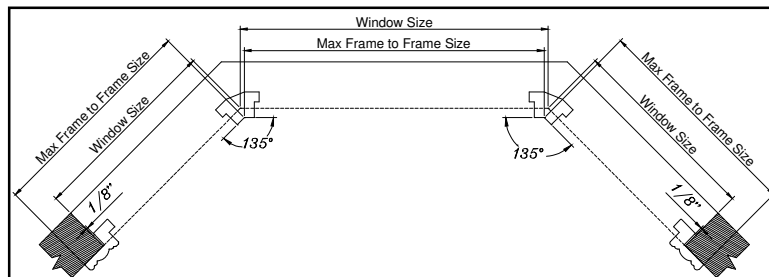

Z Frame Inside Mount

Measuring For Bay Window

Bay Window (con't)

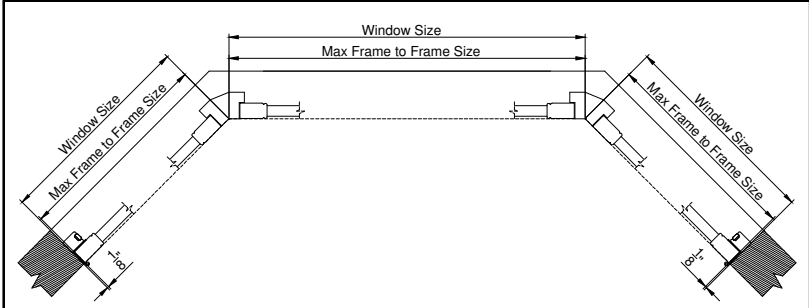

Hang Strip Inside Mount

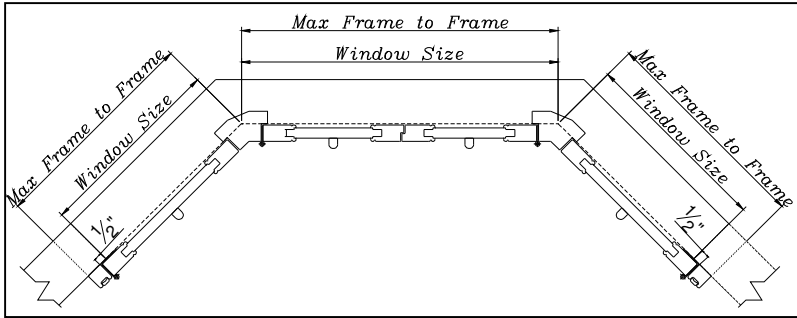

Hang Strip Outside Mount

Measuring For T Post

T Post

- T Post can be used to
 - ◇ divides window vertically to match window design with mullion
 - ◇ accommodate wider window opening/window with mullion
 - allows shutters to be operated individually for better privacy and light control
- Custom T Posts are available to accommodate wider mullions and can be used with any frame type.

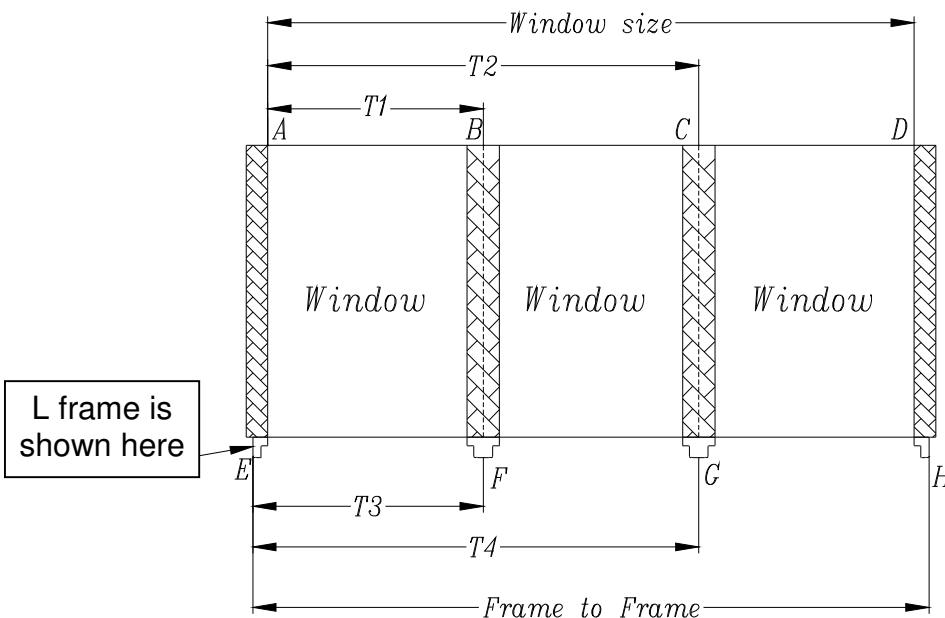

Measuring T Post location for Window Size

1. T1 = measure point A to point B
2. T2 = measure point A to point C
3. Measure from point A to point D for the overall window size.

Measuring T Post location for Max Frame to Frame

1. T3 = measure point E to point F
2. T4 = measure point E to point G
3. Measure from point E to point H for overall Max Frame to Frame size.

Measuring For T Post

T Post for Hang Strip

OM

- Window size measurement:
 - ◇ T Post is notched in order to fit into the window opening. T Post front face is flushed with hang strip front face.
- Max Frame to Frame measurement:
 - ◇ T Post will not be notched as the distance of the hang strip from the window edge cannot be determined.

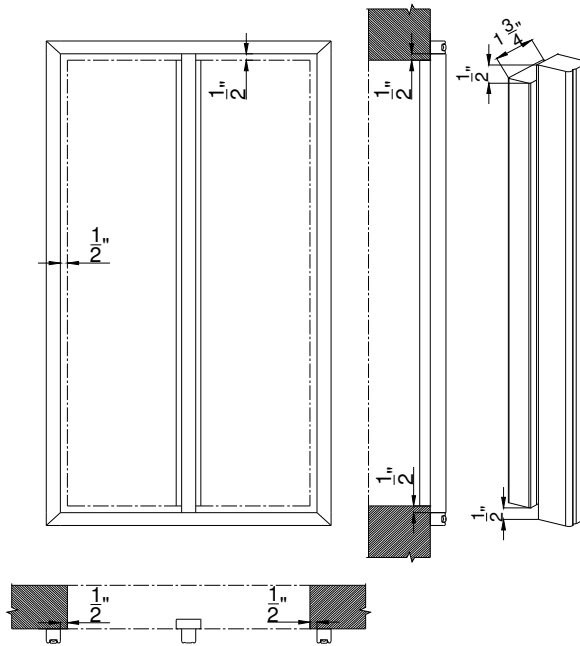

Measuring For Other Window Situation

Other Window Situation

When there is an **obstruction**:

- For the example of a side-by-side window, or when there is obstruction such as a cabinet or wall, Max Frame to Frame measurement is preferred.

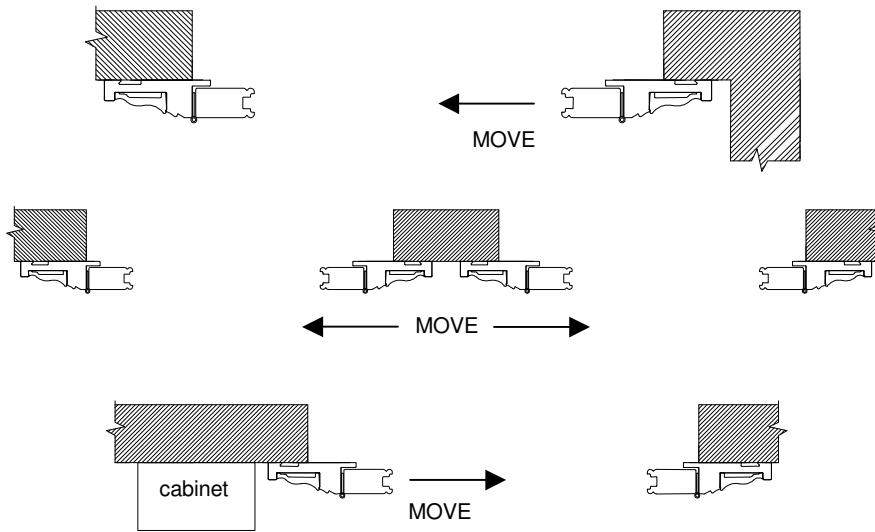

For windows with **protruding cranks**:

- Tilt out Z frame and Notch out L frame can be used for windows with protruding cranks or other obstructions.
- Tilt out Z frame requires less depth, leaving more room for tilt out windows to operate.

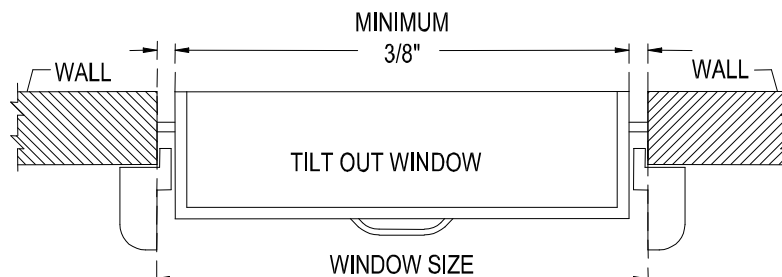

All drawings above are shown in Deco Frame

Measuring For Other Window Situation

Other Window Situation

When there is a **bullnose wall**:

- ◇ Place frame on the flat part of the wall (where the curve ends) for both OM and IM width as shown below.
- ◇ Please provide the smallest measurement for IM.

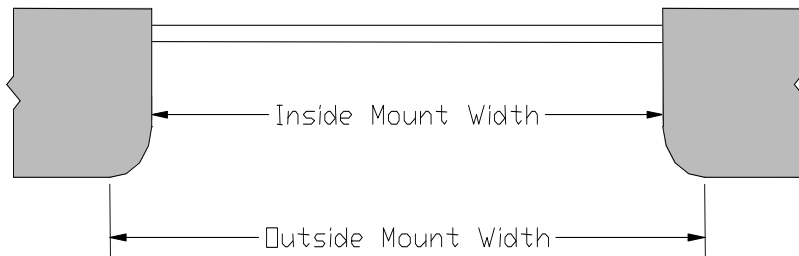

*** Please measure from the point where bullnose ends and flat wall begins.

For windows with **molding, casing or trim**:

- ◇ Frame can be placed on the molding or beside the molding (see drawing below).
- ◇ Please provide Max Frame to Frame measurement.

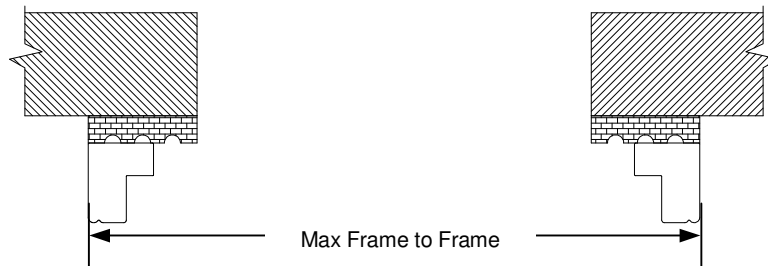

Drawings are shown in L frame